

Article number: 20479B830

Description: E+G Sensor holders - GN 479-B8-30

Measures

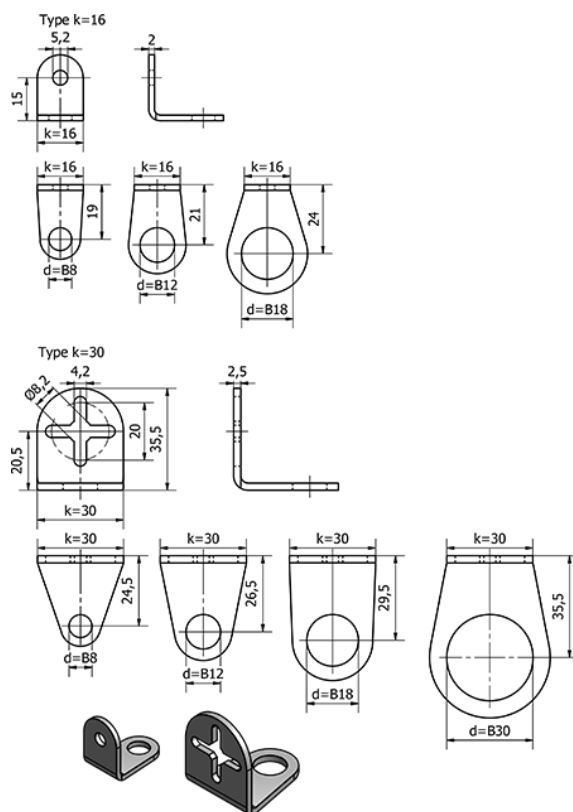

d	= 8
k	= 30
Weight (g)	= 24